

STIHL[®]

STIHL TS 800

Instruction Manual



Contents

Guide to Using this Manual	2
Safety Precautions and Working Techniques	2
Sample Applications	11
Cutting Wheels	14
Composite Abrasive Wheels	14
Diamond Abrasive Wheels	15
Assembling the bearing and guard	18
Tensioning the ribbed V-belt	21
Mounting an Abrasive Wheel	22
Fuel	23
Fueling	24
Starting / Stopping the Engine	25
Air Filter System	27
Adjusting the Carburetor	28
Spark Arresting Screen in Muffler	29
Spark Plug	30
Replacing the V-belt	31
Cut-off Machine Cart	31
Storing the Machine	32
Maintenance and Care	33
Main Parts	35
Specifications	36
Maintenance and Repairs	37
Disposal	37

Dear Customer,

Thank you for choosing a quality engineered STIHL product.

It has been built using modern production techniques and comprehensive quality assurance. Every effort has been made to ensure your satisfaction and trouble-free use of the product.

Please contact your dealer or our sales company if you have any queries concerning this product.

Your



Dr. Nikolas Stihl

STIHL®

Guide to Using this Manual

Pictograms

Pictograms that appear on the machine are explained in this Instruction Manual.

Depending on the machine and equipment version, the following pictograms may appear on the machine.



Fuel tank; fuel mixture of gasoline and engine oil

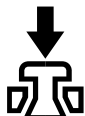

Actuate decompression valve

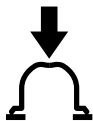

Actuate manual fuel pump



Water connection, shut-off cock



Tensioning nut for belt



Pull starter grip

Symbols in text



WARNING

Warning where there is a risk of an accident or personal injury or serious damage to property.



NOTICE

Caution where there is a risk of damaging the machine or its individual components.

Engineering improvements

STIHL's philosophy is to continually improve all of its products. For this reason we may modify the design, engineering and appearance of our products periodically.

Therefore, some changes, modifications and improvements may not be covered in this manual.

Safety Precautions and Working Techniques



Special safety precautions must be taken when working with the cut-off machine, due to the very high rotational speed of the abrasive wheel.



It is important you read and understand the Instruction Manual before first use and keep the manual in a safe place for future reference. Non-observance of the safety instructions may result in serious or even fatal injury.

Comply with national safety regulations, e.g. issued by employers' liability insurance associations, social security institutions, occupational safety and health authorities or other organizations.

For employers within the European Union, Directive 2009/104/EC is binding – Minimum safety and health requirements for the use of work equipment by workers at work.

Anyone using the power tool for the first time: Let the retailer or another expert explain to you how to handle it safely – or attend a training course.

Minors are not allowed to use the power tool, except adolescents above 16 years of age receiving instruction under supervision.

Keep children, animals and bystanders at a safe distance.

When the machine is not in use, put it down safely so that it does not endanger anyone. The machine must be secured against unauthorized access.

The user is responsible for accidents or hazards to third parties or damage to their property.

Hand over or lend the power tool only to persons who are familiar with this model and its handling – always give them the instruction manual as well.

The use of noise-emitting machines may be restricted to certain times by national or local regulations.

The machine may only be operated by people who are fit, in good physical health and in good mental condition.

If you have any condition that might be aggravated by strenuous work, check with your doctor before operating a power tool.

If you have a pacemaker: The ignition system of this machine produces an electromagnetic field of very low intensity. An effect on individual pacemaker types cannot be excluded entirely. STIHL recommends that you consult your doctor and the manufacturer of your pacemaker in order to avoid health hazards.

Never work with the machine while under the influence of alcohol, medication or drugs capable of impairing your reaction speed.

Postpone the work if the weather is bad (snow, ice, wind) – **higher risk of accidents!**

The machine is designed only for cutting as specified. It is not suitable for cutting wood or wooden objects.

Asbestos dust is extremely toxic – the machine must therefore **never be used to cut asbestos!**

Do not use the machine for any other purpose because of the increased risk of accidents and damage to the machine.

Do not modify the machine – otherwise safety may be compromised. STIHL excludes all liability for personal injury and damage to property caused by using unauthorized attachments.

Only use abrasive wheels or accessories which have been approved by STIHL for this machine or which are technically equivalent. If you have any questions in this respect, consult a servicing dealer. Only use high-quality abrasive wheels and attachments.

Otherwise there may be a risk of accidents or damage to the machine.

STIHL recommends the use of genuine STIHL abrasive wheels and accessories. These have been optimized for the product and the user's requirements.

Do not use a pressure washer to clean the machine. The strong water jet can damage parts of the machine.

Do not spray the machine with water.



Never use circular saw blades, carbide, rescue or wood cutting attachments or saws of any kind – **these may cause fatal injuries!** Instead of uniformly removing particles as when cutting with an abrasive wheel, the teeth of a circular saw blade may snag in the material. This causes the machine to react in a highly aggressive manner with uncontrolled and extremely dangerous kickback.

Clothing and equipment

Wear proper protective clothing and equipment.



Clothing must be sturdy and snug-fitting, but allow complete freedom of movement. Wear close-fitting clothes such as a boiler suit, not a loose jacket

When cutting steel, always wear clothing made of barely flammable material (e.g., leather or cotton with flame-retardant finish) – no man-made fibers – **risk of fire due to flying sparks!**

Ensure that there are no flammable deposits (chips, fuel, oil, etc.) on your clothing.

Remove any clothes that could be trapped by moving parts, such as a scarf, tie or jewelry. Long hair must be tied up and covered.



Wear **safety boots** with steel toe caps and non-slip soles.



WARNING



To reduce the risk of eye injuries, wear tight-fitting safety goggles conforming to standard EN 166. Make sure that the safety goggles fit correctly.

Wear a face mask and make sure it fits correctly. A face mask alone is not sufficient to protect the eyes.

Wear a hard hat wherever there is any risk of falling objects.

While working, dust (for example, crystalline material from the object to be cut), vapor and smoke may be produced – **danger to health!**

Always wear a **dust mask** if dust is generated.

If fumes or smoke are anticipated (e.g., when cutting composite materials), wear **respiratory protection**.

Wear "personal" **hearing protection** – for example, ear defenders.



Wear sturdy protective gloves made of a resistant material (e.g. leather).

STIHL can supply a comprehensive range of personal protective clothing and equipment.

Transporting the machine

Always turn off the engine first.

Carry the machine by the handlebar only – abrasive wheel pointing to the rear – hot muffler away from the body.

Do not touch hot machine parts, in particular the muffler surface – **risk of burns!**

Never transport the power tool with cutting wheel fitted – **risk of breakage!**

In vehicles: Properly secure the machine to prevent turnover, damage and fuel spillage.

Refueling



Gasoline is an extremely flammable fuel – keep clear of naked flames and fire – do not spill any fuel – no smoking.

Switch off the engine before refueling.

Never refuel the machine while the engine is still hot – the fuel may spill over – **risk of fire!**

Open the fuel filler cap carefully so that any excess pressure is relieved gradually and fuel does not splash out.

The machine may only be refueled in a well ventilated place. If fuel has been spilled, immediately clean the machine – do not allow your clothes to be splashed with fuel. If that happens, change your clothes at once.

Dust may collect on the engine unit, especially around the carburetor. If dust gets mixed with fuel – risk of fire! Remove the dust from the engine unit regularly.



Look out for leaks! Never start the engine if fuel has been spilled or is leaking – **Fatal burns may result!**

Different cut-off machines may be equipped with different filler caps:

Bayonet filler cap

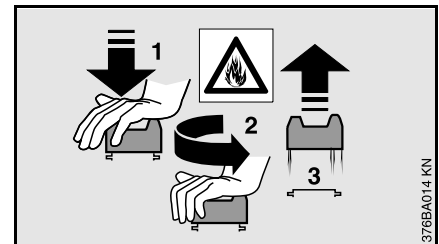

Never use a tool to open or close the bayonet filler cap. The cap can be damaged and fuel may escape.

Secure the bayonet filler cap tightly after refueling.

Filler cap with screw thread



Close the filler cap as tightly as possible after refueling.

This helps reduce the risk of engine vibrations causing an incorrectly tightened filler cap to loosen or come off and spill quantities of fuel.

Cut-off machine, spindle bearing

Correct spindle bearings ensure the concentricity and axial running of the diamond-tipped abrasive wheel – if necessary, get it checked by an approved dealer.

Abrasive wheels

Selecting the abrasive wheels

Abrasive wheels must be approved for hand-held cutting. Do not use other cutting wheels and attachments – **risk of accident!**

Abrasive wheels are suitable for different materials: Observe the identification of the abrasive wheels.

STIHL generally recommends wet cutting.

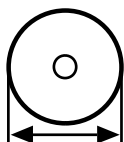

Observe the outer diameter of the abrasive wheel.

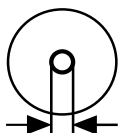

Spindle hole diameter of the abrasive wheel and shaft of cut-off machine must match.

Check the spindle hole for damage. Do not use cutting wheels with a damaged spindle hole – **risk of accident!**



The permissible speed of the abrasive wheel must be equal to or greater than the maximum spindle speed of the cut-off machine. – Refer to the chapter "Specifications".

Before fitting a used abrasive wheel, check that it is not cracked, chipped, undercut or uneven, and does not display any signs of core fatigue or overheating (discoloration); check also that there are no damaged or missing segments and that the spindle hole is not damaged.

Never use cracked, chipped or bent abrasive wheels.

Substandard and/or unapproved diamond abrasive wheels can shimmy during cutting. This shimming can cause such diamond abrasive wheels to be abruptly braked or become stuck in the cut – **Danger of kickback! Kickback can result in fatal injuries!** Diamond abrasive wheels that shimmy constantly or even only intermittently must be replaced immediately.

Never straighten diamond abrasive wheels.

Do not use a cutting wheel which has fallen to the ground – damaged cutting wheels may break – **risk of accident!**

Observe the expiration date where resin abrasive wheels are concerned.

Fitting abrasive wheels

Inspect the spindle of the cut-off machine. Do not use a machine if the spindle is damaged – **risk of accident!**

Note the arrows indicating the direction of rotation on diamond abrasive wheels.

Position the front pressure plate – tighten up the clamping screw – rotate the cutting wheel by hand and take a sight check for concentricity and axial running.

Storing abrasive wheels

Store cutting wheels in a dry and frost-free place, on an even surface, at constant temperature – **risk of breakage and splintering!**

Always protect the abrasive wheel against sudden contact with the ground or objects.

Before starting

Inspect the cut-off machine to check that it is in full working order – observe the respective chapters in the instruction manual:

- Check the fuel system for leaks, especially the visible parts, e.g., filler cap, hose connections, manual fuel pump (only on machines with a manual fuel pump). In case of leakage and damage, do not start the engine – **risk of fire!** Have the machine serviced by a servicing dealer before using it.
- The abrasive wheel must be suitable for the material to be cut. It must be in good condition and fitted correctly (direction of rotation, secure).
- Inspect the cutting wheel guard for tight seat – if loose, contact your specialist dealer.

- Both the throttle trigger and the throttle trigger lockout must move smoothly – the throttle trigger must automatically return to the idle position.
- Slide control / master control / stop switch must move easily to **STOP** or **0**
- Check that the spark plug boot is secure. A loose boot can lead to flying sparks which may ignite the escaping fuel/air mixture – **risk of fire!**
- Never attempt to modify the controls or safety devices in any way
- Keep the handles clean, dry, and free of oil and dirt – important for good control of the cut-off machine.
- For wet applications, provide sufficient water

The machine should only be used if it is in good working order – **risk of accident!**

Starting the engine

Move at least 3 meters away from the place at which the machine was refueled and never start the machine in an enclosed space.

On even ground, ensure a firm and secure footing and hold the power tool firmly – the cutting wheel must not touch the ground or any objects and must not be in the cut.

The abrasive wheel may begin to rotate as soon as the machine is started.

The machine is operated by a single person only – do not allow anyone else within the working area – not even when starting.

Do not drop-start the engine – start as described in the Instruction Manual.

After releasing the throttle trigger, the abrasive wheel keeps on running for a while – **danger of injury due to coasting effect!**

Holding and controlling the machine

The cut-off machine may only be used for hand-held cutting or when mounted on a STIHL cut-off machine cart.

Hand-held cutting

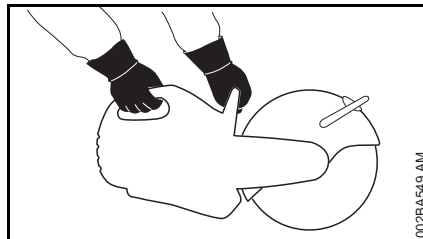

Always hold the machine **firmly with both hands**: Right hand on the rear handle – even if you are left-handed. To ensure reliable control, wrap your thumbs tightly around the handlebar and handle.

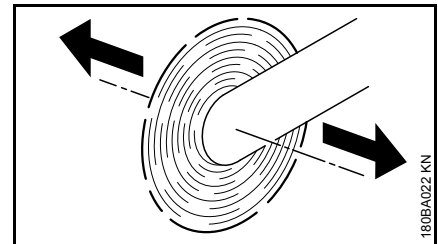

When a cut-off machine with an abrasive wheel rotating is moved in the direction of the arrow, a force is produced which causes the machine to tip sideways.

The object to be cut has to be firmly supported. Always guide the machine towards the workpiece, never the other way round.

Cut-off machine cart

STIHL cut-off machines can be mounted on a STIHL cut-off machine cart.

Guard

The adjustment range of the guard is determined by a stop pin. Never push the guard over the stop pin.

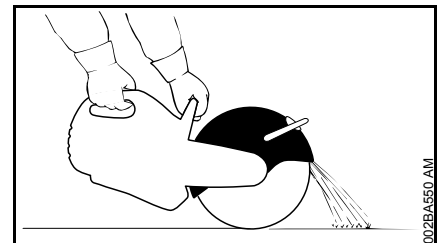

Set the abrasive wheel guard correctly: Direct particles of material away from the user and machine.

Note the direction of travel of the abraded particles of material.

During operation

If there is imminent danger or in an emergency, immediately stop the engine – set the slide control / master lever /stop switch to **STOP** or **0**.

Check for correct idling so that the abrasive wheel is no longer driven when the throttle trigger is released and comes to a complete halt.

Check and/or correct the idle setting regularly. Have the machine repaired by a STIHL servicing dealer if the cutting wheel continues to turn nevertheless.

Keep the working area clear – bear in mind obstacles, holes and pits.

Take care on ice, water, snow, on slopes or uneven ground, etc. – **risk of slipping!**

Do not work while standing on a ladder – or in unstable places – not above your shoulder height – not with one hand only – **risk of accident!**

Ensure you always have a firm and secure footing.

Never work alone – always stay in earshot of other persons who can help in an emergency.

Keep everyone else away from the working area – maintain a sufficient distance from other people to protect them from noise and flying objects.

Pay increased attention and take greater care when wearing ear defenders – the perception of sounds indicating potential danger (shouts, audible warnings, etc.) is restricted.

Take a break before it is too late.

Work calmly and carefully – in daylight conditions and only when visibility is good. Work with particular care, do not endanger others.



Your power tool produces toxic exhaust fumes as soon as the engine starts running. These gases may be colorless and odorless and may contain unburnt hydrocarbons and benzene. Never use the machine indoors or in poorly ventilated areas – even if your model is equipped with a catalytic converter.

Ensure proper ventilation when working in trenches, hollows or similar locations – **risk of fatal injury from breathing toxic fumes!**

Stop working immediately if you feel sick, have a headache, distorted vision (for example, shrinking field of vision), hearing impairment, dizziness, fading powers of concentration – such symptoms may be caused, among other things, by excessive exhaust concentrations – **risk of accident!**

No smoking when working with or near the machine - **risk of fire!**

If the power tool has been exposed to stress due to improper use (e.g. forceful impact by striking or dropping), inspect the machine to make sure it is in full working order before continuing work, in every case – see also "Before start-up". Check the fuel system for leaks and make sure the safety devices are working properly. Do not continue

operating a machine which is damaged. In case of doubt, have the unit checked by your servicing dealer.

Do not work with the throttle trigger in the starting throttle position – in that position of the throttle trigger, the engine speed cannot be controlled.

Never touch a rotating abrasive wheel with your hand or any other part of your body.

Check the work area. Avoid danger due to damage to pipes and electric power lines.

The machine must not be used in the vicinity of flammable substances and combustible gases.

Do not cut into pipes, metal tanks or other containers unless you are absolutely sure that they do not contain any volatile or flammable substances.

Never leave the machine unattended with the engine running. Stop the engine before leaving the machine unattended (e.g. for breaks).

Before putting the cut-off machine down on the ground:

- Switch off the engine
- Wait until the abrasive wheel has come to a standstill or brake the abrasive wheel until it comes to a standstill by carefully touching a hard surface (e.g., concrete slab)



Frequently inspect the cutting wheel – replace the wheel right away if there are visible cracks, buckling or other damage (for example, overheating) – **risk of accident due to breakage!**

In the event of changes in cutting behavior (e.g., increased vibration, reduced cutting performance), stop work and eliminate the causes of the changes.

Reactive forces

The most frequently occurring reactive forces are kickback and pull-in.



Danger of kickback – **Kickback can result in fatal injuries.**

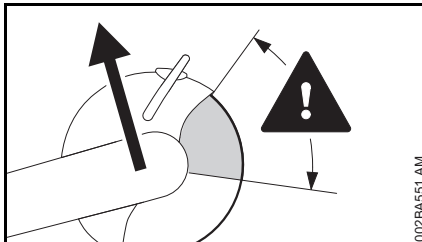

Kickback occurs when the cut-off machine is suddenly thrown up and back in an uncontrolled arc towards the operator.

Kickback occurs if, for example, the abrasive wheel

- gets jammed – especially the upper quarter, or
- is abruptly braked through friction contact with a solid object

Reducing the risk of kickback

- Work cautiously and methodically
- Hold the cut-off machine firmly with both hands and maintain a secure grip

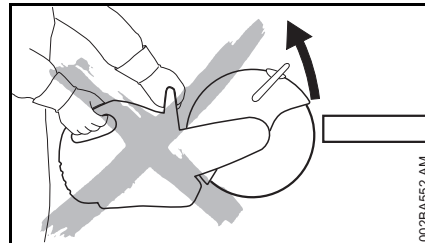

- Do not use the upper quarter of the abrasive wheel for cutting. Use extreme caution when guiding the abrasive wheel into a cut, do not twist or push into the cut

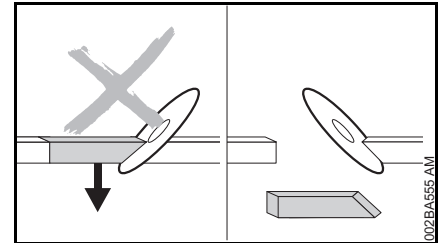

- Avoid any wedge effect - the severed part must not brake the abrasive wheel
- Always be aware that the object to be cut may move and other factors may cause the cut to close and jam the abrasive wheel.
- The object to be cut must be secured and supported so that the kerf remains open during and after cutting
- Objects to be cut must therefore be fully supported and must be secured against rolling away, slipping off or vibrations

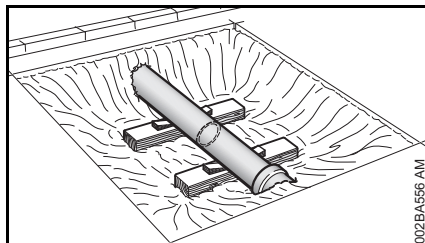

- An exposed pipe must be provided with a stable support that will bear its weight, using wedges if necessary – always bear in mind a proper support and the nature of the ground – material may crumble away
- Always work with water and wet cutting when using diamond abrasive wheels
- Depending on the version, resin abrasive wheels are only suitable for dry cutting or only for wet cutting. Always use wet cutting with composite resin abrasive wheels that are suitable only for wet cutting

Pulling away

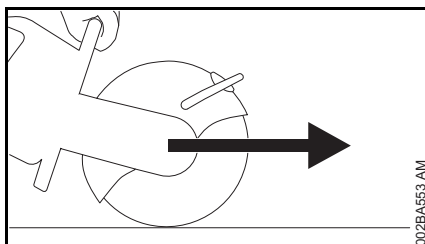

The cut-off machine pulls forwards, away from the user, when the abrasive wheel touches the object to be cut from above.

Working – cutting



The abrasive wheel must be guided straight in the cut, without wedging. Never exert lateral pressure on the abrasive wheel.



Do not use for lateral grinding or roughing.

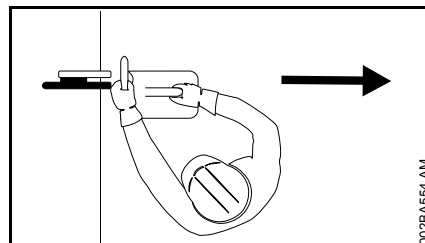

Do not stand in line with the abrasive wheel. Ensure sufficient freedom of movement, especially in construction trenches there must be sufficient space for the user and for the part being cut to fall.

Do not lean too far forwards and never bend over the abrasive wheel, especially when the guard has been pulled back.

Do not work above shoulder height.

The cut-off machine may only be used for cutting. It must not be used as a lever or shovel.

Do not press down on the cut-off machine.

Always decide the cutting direction before positioning the cut-off machine. Do not change the cutting direction. Never use the machine to push or hit into the cutting gap – do not let the machine fall into the gap – **risk of breakage!**

Diamond abrasive wheels: If cutting performance begins to deteriorate, check the sharpness of the diamond cutting wheel, sharpen as needed. To do this, briefly cut through abrasive material, e.g., sandstone, aerated concrete or asphalt.

At the end of the cut, the cut-off machine is no longer supported in the cut by the abrasive wheel. The user has to absorb the weight force – **risk of loss of control!**



When cutting steel: glowing metal particles **may cause fires!**

Keep water and sludge away from live electrical cables – **risk of electric shock!**

Pull the cutting wheel into the workpiece – do not push it into the material. Do not use the cut-off machine to correct severing cuts. Do not re-cut – remove any webs or breaking edges manually (for example, with a hammer).

When using diamond-coated cutting wheels, make a wet cut – for example, use the STIHL water connector.

Depending on the version, resin abrasive wheels are only suitable for dry cutting or only for wet cutting.

When using cutting wheels made from synthetic resin which are suitable for wet cuts only, make wet cuts only – for example, use the STIHL water connector.

When using abrasive wheels made from synthetic resin, which are suitable for dry cuts only, make dry cuts only. If composite resin abrasive wheels of this type become wet, their cutting performance is reduced and they become dull. If composite resin abrasive wheels of this type become wet while working (e.g., due to puddles or water in pipes), do not increase the cutting pressure, but continue working with the same pressure – **risk of breakage!** Use up such composite resin abrasive wheels immediately.

Cut-off machine cart

Clear a path for the cut-off machine cart. If the cart is pushed over objects, the abrasive wheel may become wedged in the cut and **shatter!**

Vibrations

Prolonged use of the power tool may result in vibration-induced circulation problems in the hands (whitefinger disease).

No general recommendation can be given for the length of usage because it depends on several factors.

The period of usage is prolonged by:

- Hand protection (wearing warm gloves)
- Work breaks

The period of usage is shortened by:

- Any personal tendency to suffer from poor circulation (symptoms: frequently cold fingers, tingling sensations).
- Low outside temperatures.
- The force with which the handles are held (a tight grip restricts circulation).

Continual and regular users should monitor closely the condition of their hands and fingers. If any of the above symptoms appear (e.g. tingling sensation in fingers), seek medical advice.

Maintenance and repairs

The machine must be serviced regularly. Do not attempt any maintenance or repair work not described in the Instruction Manual. All other work should be carried out by a servicing dealer.

STIHL recommends that maintenance and repair work be carried out only by authorized STIHL dealers. STIHL dealers receive regular training and are supplied with technical information.

Use only high-quality replacement parts, in order to avoid the risk of accidents or damage to the machine. Contact a dealer if in doubt.

STIHL recommends the use of genuine STIHL spare parts. Such parts have been optimized for the machine and the user's requirements.

Before starting any maintenance or repair work and before cleaning the machine, always **stop the engine and disconnect the spark plug boot – risk of**

injury if the engine starts up inadvertently! – Exception: adjustment of carburetor and idle speed.

To reduce the **risk of fire** due to ignition outside the cylinder, move the slide control / stop switch to **STOP** or **0** before turning the engine over on the starter with the spark plug boot removed or the spark plug unscrewed.

Do not service or store the machine near a naked flame – **risk of fire** due to the fuel.

Check fuel cap regularly for tightness.

Use only spark plugs that are in perfect condition and have been approved by STIHL – see Specifications.

Inspect ignition lead (insulation in good condition, secure connection).

Check that the muffler is in perfect working condition.

Do not use the machine if the muffler is damaged or missing - **risk of fire!** – **Hearing damage!**

Never touch a hot muffler – **risk of burns!**

Check the rubber buffers underneath the machine - the housing must not rub against the ground - **risk of damage!**

The condition of the antivibration elements influences vibration behavior – inspect antivibration elements periodically.

Sample Applications

Water must always be used for wet cutting when working with diamond abrasive wheels

Extend service life and increase cutting speed

Always ensure a supply of water to the abrasive wheel.

Binding dust

The abrasive wheel must be supplied with at least 0.6 liters of water per minute.

Water attachment

- Water attachment on the machine for all types of water supplies
- Pressurized water tank 10 l for binding dust
- water tank usable on the cut-off machine cart for binding dust

Use composite resin abrasive wheels with or without water – depending on version

Depending on the version, resin abrasive wheels are only suitable for dry cutting or only for wet cutting.

Composite resin abrasive wheels suitable only for dry cutting

During dry cutting, wear a suitable dust mask.

If fumes or smoke are anticipated (e. g., when cutting composite materials), wear **respiratory protection**.

Composite resin abrasive wheels suitable only for wet cutting



Use abrasive wheel only with water.

To bind dust, the abrasive wheel must be supplied with at least 1 liter of water per minute. To avoid a reduction in cutting performance, the abrasive wheel must be supplied with not more than 4 liters of water per minute.

After using the abrasive wheel, the wheel should be allowed to continue spinning at operating speed for approx. 3 to 6 seconds without water in order to spin off the water remaining on it.

- Water attachment on the machine for all types of water supplies
- Pressurized water tank 10 l for binding dust
- water tank usable on the cut-off machine cart for binding dust

Observe with diamond and composite resin abrasive wheels

Objects to be cut

- Must be fully supported
- Must be secured so it cannot roll or slip off
- Must be prevented from vibrating

Severed parts

With openings, recesses, etc., the sequence of the cuts is important. Always make the last cut so that the abrasive wheel does not become jammed and so that the operator is not endangered by the severed or separated part.

If necessary, leave small ridges that hold the part that is to be separated in position. Break these ridges later.

Before finally separating the part, determine:

- how heavy the part is
- how it can move after separation
- whether it is under tension

When breaking out the part, do not endanger assistants.

Cut in several passes

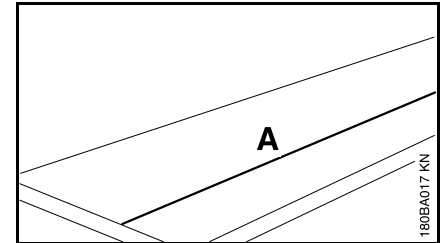

- Mark cutting line (A)

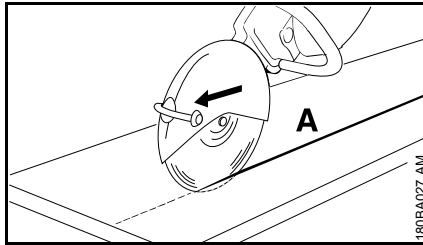

- Work along the cutting line. When making corrections, do not tilt the abrasive wheel, but always set the abrasive wheel against the workpiece anew – the cutting depth for each operation should not exceed 5 to 6 cm. Cut thicker material in multiple operations

Cutting plates

- Secure the plate (e. g. on a non-slip surface, sandbed)

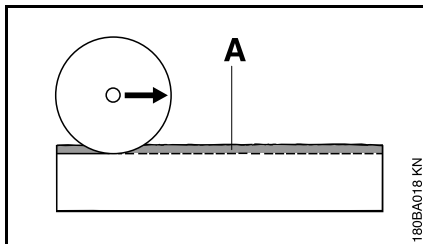

- Grind a guide groove (A) along the line marked

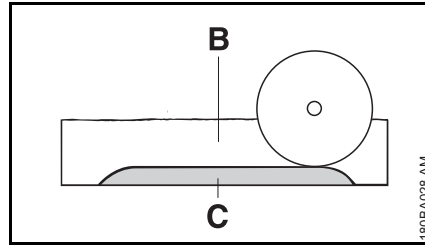

- Make the cut (B) deeper
- Leave a "hinge" (C)
- First sever the plate at the cut ends so that no material breaks away
- Break plate

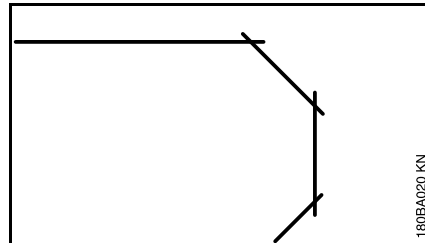

- Make curves in multiple operations – make certain that the abrasive wheel does not tilt

Cutting pipes, round and hollow bodies

- Secure pipes, round and hollow bodies against vibrations, slipping and rolling away
- Note direction of fall and weight of the severed part
- Determine and mark the cutting line, avoid reinforcement, especially in the direction of the severing cut
- Determine sequence of severing cuts

- Grind a guide groove along the line marked
- Make cut deeper along the guide groove – observe the recommended cutting depth for each operation – for small corrections of direction, do not tilt the abrasive wheel, but always position it anew instead – if necessary, leave small ridges that hold the part that is to be separated in position. Break these ridges after the last planned cut

Cutting concrete pipe

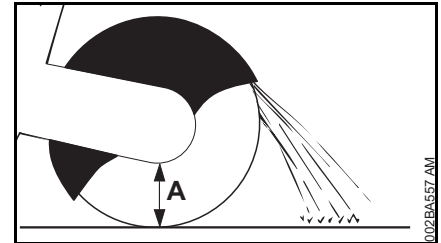

The procedure is dependent on the outer diameter of the pipe and the maximum possible cutting depth of the abrasive wheel (A).

- Secure pipe against vibrations, slipping and rolling away
- Note weight, tension and direction of fall of the part to be severed

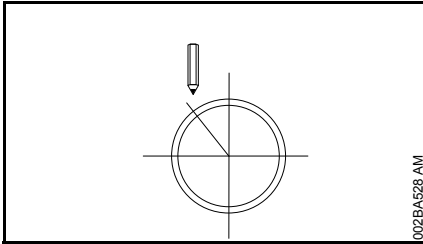

002BA528 AM

- Determine and mark direction of cut
- Determine sequence of cuts

Outer diameter is smaller than the maximum cutting depth

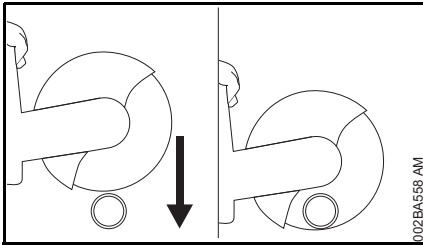

002BA558 AM

- Make **one** cut from the top to the bottom

Outer diameter is greater than the maximum cutting depth

Plan first, then cut. **Several** cuts are needed – correct sequence is important.

- Turn guard at rear stop

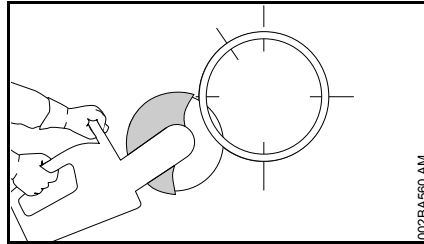

002BA560 AM

- Always start at the bottom, use the upper quarter of the abrasive wheel for cutting

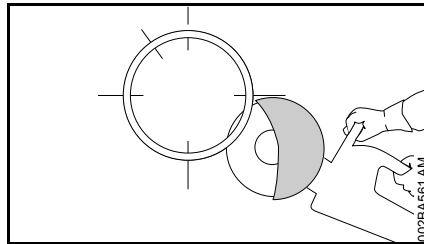

002BA561 AM

- Use the upper quarter of the abrasive wheel for cutting the opposite lower side.

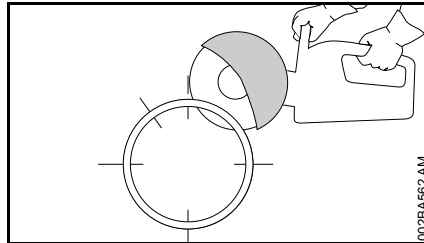

002BA562 AM

- First lateral cut on the top half of the pipe

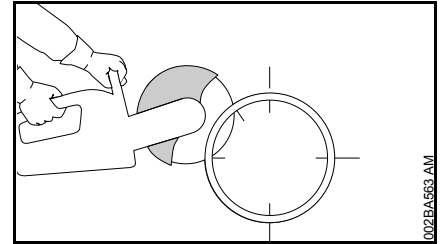

002BA563 AM

- Second lateral cut in the marked area – never cut into the area of the last cut, to ensure a firm hold on the part of pipe to be cut

Only make the last top cut once all bottom and lateral cuts have been made.

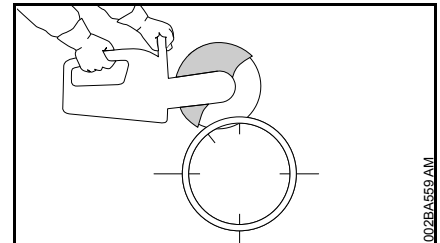

002BA569 AM

- Last cut always from the top (approx. 15 % of the pipe circumference)

Concrete pipe – cut recess

Sequence of cuts (1 to 4) is important:

- First, cut hard-to-reach areas

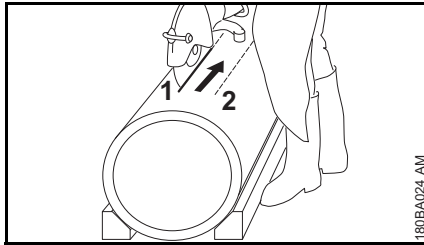

- Always make severing cuts so that the abrasive wheel is not pinched

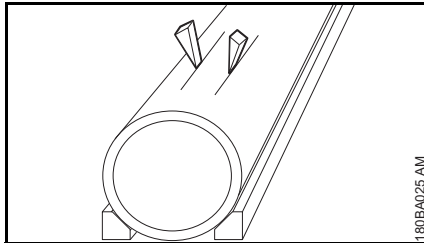

- Use wedges and/or leave ridges that are broken after cutting

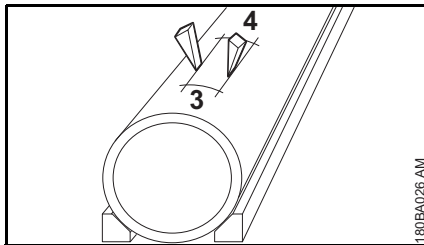

- If the severed part remains in the recess after cutting (due to wedges, ridges used), do not make any further cuts – break the severed part

Cutting Wheels

Abrasive wheels are exposed to extremely high loads especially during freehand cutting.

Therefore only for use of approved and correspondingly labeled abrasive wheels with hand-held machines as per EN 13236 (diamond) or EN 12413 (composite resin). Note maximum permissible speed of the abrasive wheel – **risk of accident!**

The abrasive wheels, which have been developed by STIHL in cooperation with renowned manufacturers of abrasive wheels, are of high quality and tailored precisely to the respective intended use as well as the engine performance of the cut-off machine.

They are of consistently outstanding quality.

Transport and storage

- Do not expose abrasive wheels to direct sunshine or other thermal stresses during transport and storage
- Avoid jolting and impacts
- Stack abrasive wheels flat on a level surface in the original packaging in a dry place where the temperature is as constant as possible
- Do not store abrasive wheels in the vicinity of aggressive fluids
- Store abrasive wheels in a frost-free place

Composite Abrasive Wheels

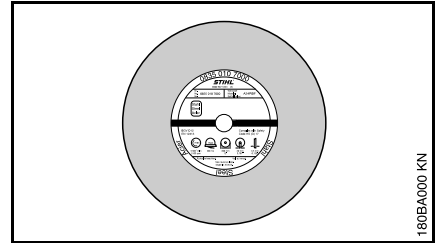

Types:

- for dry applications
- for wet applications

The proper selection and use of composite resin cutting wheels ensures economical use and avoids accelerated wear. The product code which appears

- on the label and
- on the packaging (table with recommendations for use) is an aid to selection

STIHL composite resin cutting wheels are suitable, depending on the version, for cutting the following materials:

- Asphalt
- Concrete
- Stone
- Ductile cast iron pipes
- Steel; STIHL composite resin cutting wheels are not suitable for cutting railway tracks

Do not cut any other materials – **risk of accident!**

Diamond Abrasive Wheels

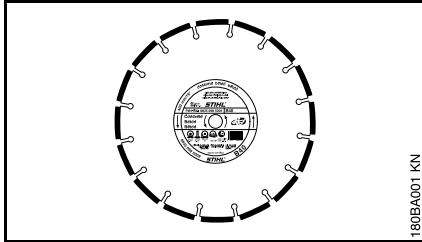

180BA001 KN

For wet applications.

The proper selection and use of diamond abrasive wheels ensures economical use and avoids accelerated wear. The product code which appears

- on the label and
- on the packaging (table with recommendations for use) is an aid to selection

STIHL diamond abrasive wheels are suitable, depending on the version, for cutting the following materials:

- Asphalt
- Concrete
- Stone (hard stone)
- Abrasive concrete
- Fresh concrete
- Clay brick
- Clay pipe
- Ductile cast iron pipe

Do not cut any other materials – **Risk of accident!**

Never use diamond abrasive wheels with side plating as they jam in the cut and can result in extreme kickback – **Risk of accident!**

Product Codes

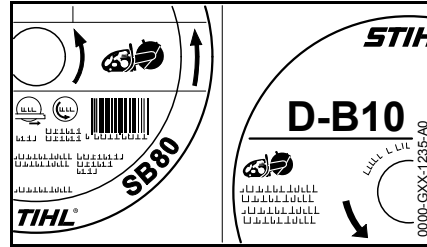

The product code is a combination of letters and numbers, consisting of up to four characters:

- the letters denote the main field of application of the abrasive wheel
- the numbers denote the performance class of the STIHL diamond abrasive wheel

Axial and radial run-out

A faultless spindle bearing of the cut-off machine is necessary for a long service life and efficient functioning of the diamond abrasive wheel.

Using the abrasive wheel on a cut-off machine with a faulty spindle bearing can lead to deviations in radial and axial run-out.

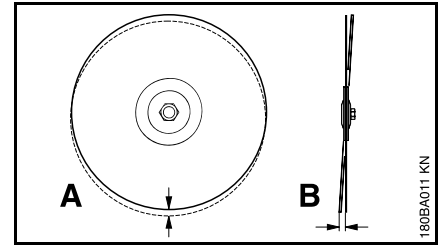

180BA011 KN

An excessively high radial run-out deviation (A) overloads individual diamond segments, which overheat in the process. This can lead to stress cracks in the parent wheel or to annealing of individual segments.

Deviations in axial run-out (B) result in higher thermal loading and wider cuts.

Undercut

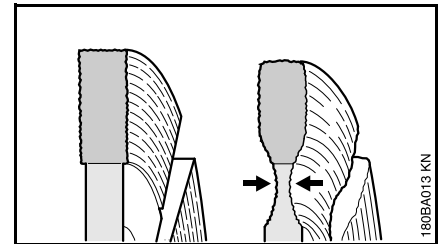

180BA013 KN

Do not cut into the base course (frequently chipped stones and gravel) when cutting roadway pavement – cutting in chipped stones and gravel is revealed by light-colored dust – excessive undercut may occur as a result – **Danger of shattering!**

Built-up edges, sharpen

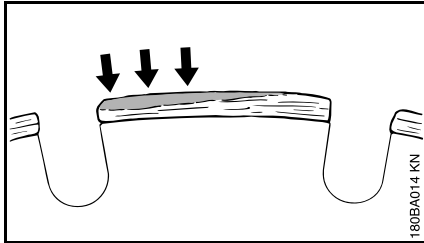

Built-up edges take the form of a light gray deposit on the tops of the diamond segments. This deposit on the segments clogs the diamonds and blunts the segments.

Built-up edges can form:

- when cutting extremely hard materials, e. g., granite
- with incorrect handling, e. g., excessive feed effort

Built-up edges increase vibration, reduce cutting performance, and cause formation of sparks.

At the first signs of built-up edges, immediately "sharpen" the diamond abrasive wheel – to do this, briefly cut through abrasive material such as sandstone, aerated concrete or asphalt.

Addition of water prevents the formation of built-up edges.

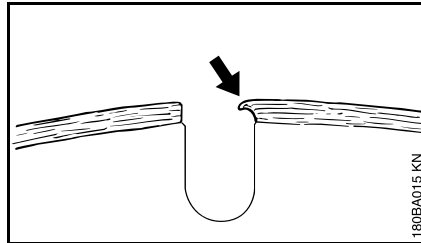

If work continues with dull segments, these may soften due to the high heat generated – the parent wheel is annealed and its strength is compromised – this can lead to stresses that are clearly recognizable by gyrations of the abrasive wheel. Do not continue to use the abrasive wheel – **Risk of accident!**

Troubleshooting

Abrasive wheel

Defects	Cause	Remedy
ragged edges or cut surfaces, crooked cut	Deviation in radial or axial run-out	Contact a servicing dealer ¹⁾
heavy wear on the sides of the segments	Abrasive wheel gyrates	use a new abrasive wheel
ragged edges, crooked cut, no cutting performance, generation of sparks	Abrasive wheel is dull; built-up edges with abrasive wheels for stone	Sharpen abrasive wheels for stone by briefly cutting through abrasive materials; replace abrasive wheel for asphalt with a new one
poor cutting performance, high segment wear	Abrasive wheel is turning in the wrong direction	Mount abrasive wheel so that it turns in the right direction
Breakdowns or tears in the parent wheel and segment	Overloading	use a new abrasive wheel
Undercut	Cutting in the wrong material	use new abrasive wheel; observe separating layers of various materials

1) STIHL recommends STIHL servicing dealers

Assembling the bearing and guard

The "support with guard" is mounted on the inboard side by the manufacturer.

The "support with guard" can also be mounted on the outboard side depending on requirements.

Assembly on the inboard side is recommended for freehand cutting on account of the better balance.

Outboard mounting

- Disassemble the abrasive wheel (see "Fitting / replacing an abrasive wheel")

Removing the water attachment

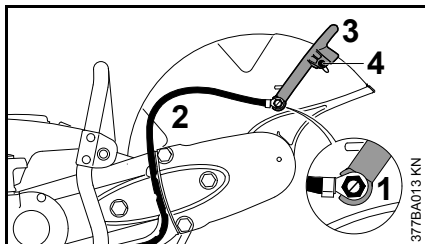

- Unscrew the banjo bolt (1) with the combination wrench – in the process, remove the square nut from the inside of the guard from the guide
- Remove the water hose (2) with connector from the adjusting lever (3)
- Unscrew the screw (4)

Removing the adjusting lever

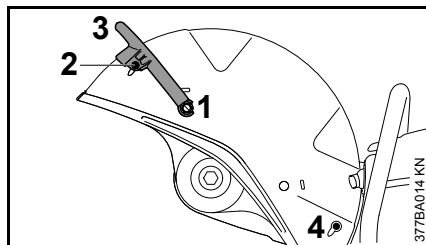

- Unscrew the banjo bolt (1) with the combination wrench and remove it together with the seal – in the process, remove the square nut from the inside of the guard from the guide
- Unscrew the screw (2)
- Turn the adjusting lever (3) upwards and remove
- Remove the sealing plug (4)

Slackening the V-belt

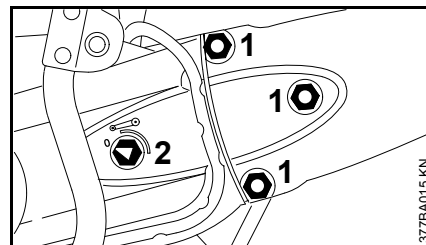

- To relax the poly V-belt, loosen the nuts (1) – do not unscrew the nuts (1) from the studs
- Turn the tensioning nut (2) counterclockwise with the combination wrench – approx. 1/4 turn, as far as it will go = 0
- Unscrew nuts (1) from the studs – nuts (1) are fastened to the belt guard so that they are secured against loss

Removing the V-belt guard

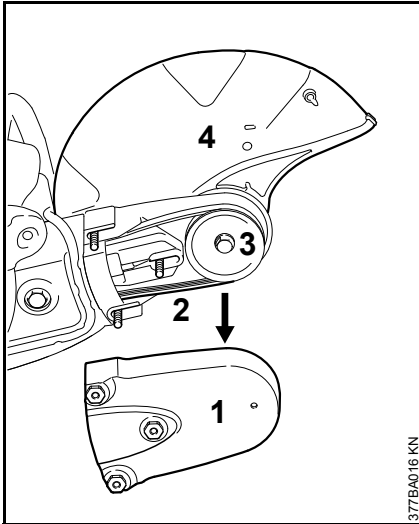

- Pull the V-belt guard (1) off and remove the V-belt (2) from the front pulley (3)
- Remove the "support and guard" (4)

Preparing the "support with guard" for outboard mounting

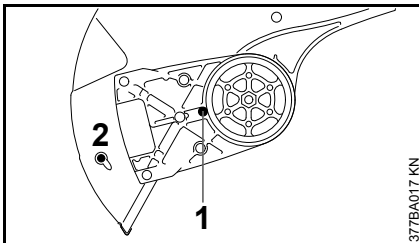

- Unscrew the stop pin (1)
- Remove the sealing plug (2)

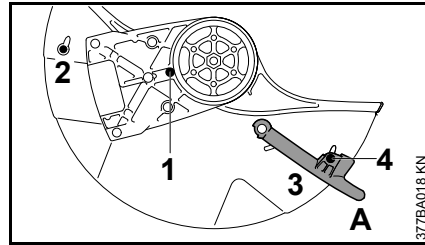

- Turn the guard so that it is in the position shown (see picture)
- Screw in and tighten the stop pin (1)
- Insert the sealing plug (2)
- Move the adjusting lever (3) to position A
- Insert and tighten the screw (4)

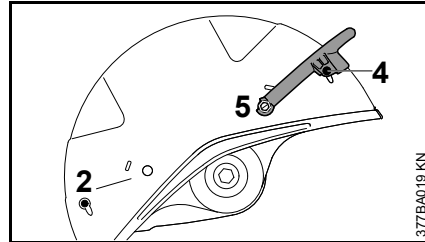

- Turn the "support with guard" so that the guard is on the outboard side
- Insert the square nut into the guide in the guard and hold it in place
- Screw in the shorter banjo bolt (5) and washer at the adjusting lever and tighten up with the combination wrench
- Insert the sealing plug (2)
- Insert and tighten the screw (4)

Mounting "support with guard" – guard on the outboard side

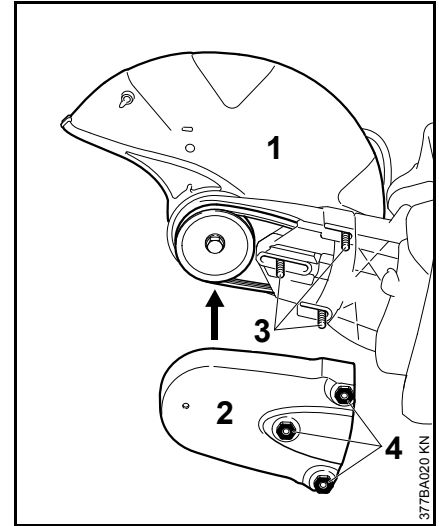

- Fit the "support with guard" (1) on the outboard side of the cast arm - at the same time, guide the V-belt over the belt pulley

NOTICE

The belt action must run smoothly.

- Position the V-belt guard (2)
- Align studs (3) in support with nuts (4) in the V-belt guard
- Screw nuts (4) onto studs (3) – do not tighten them yet

Connecting the water connection

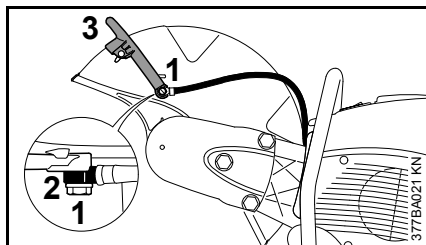

- Insert the longer banjo bolt (1) through the connector (2) of the water attachment – observe the position of the connector
- Insert the square nut into the guide in the guard and hold it in place
- Fit the support with the longer banjo bolt on the adjusting lever (3) – screw in the banjo bolt and tighten with the combination wrench

Checking the adjustment range of the guard

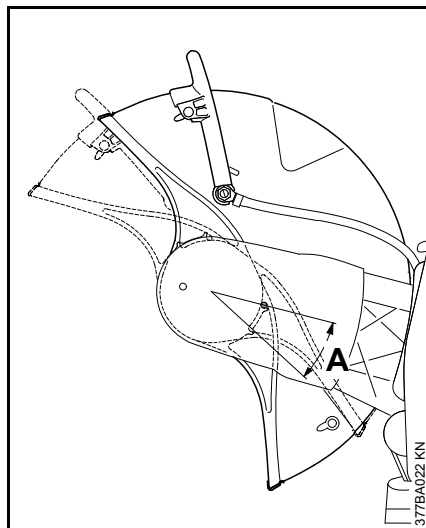

- Rotate the guard forwards and backwards as far as possible – adjustment range (A) must be limited by the stop pin

Continue as described in the chapter "Tensioning the V-belt".

Inboard mounting

- Disassemble the abrasive wheel (see "Fitting / replacing an abrasive wheel")
- Remove the water attachment
- Remove the adjusting lever
- Slacken the V-belt
- Remove the V-belt guard
- Remove "support with guard"
- Remove the sealing plug

Preparing the "support with guard" for inboard mounting

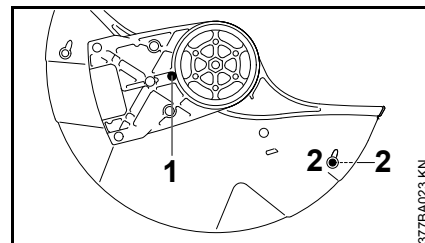

- Unscrew the stop pin (1)
- Insert both sealing plugs (2) – on the opposite side as well

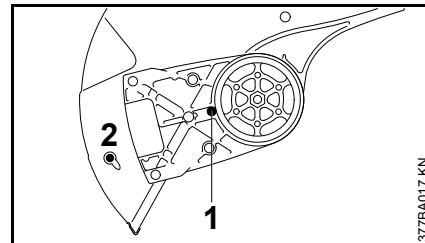

- Turn the guard so that it is in the position shown (see picture)
- Screw in and tighten the stop pin (1)
- Install the adjusting lever
- Mount "support with guard" – guard on the inboard side
- Install the V-belt guard
- Connect the water connection

Checking the adjustment range of the guard

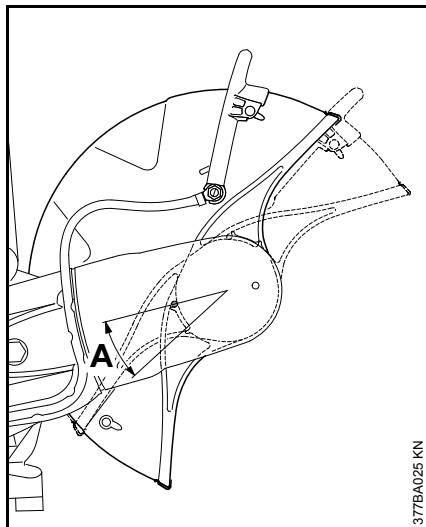

- Rotate the guard forwards and backwards as far as possible – adjustment range (A) must be limited by the stop pin

Continue as described in the chapter “Tensioning the V-belt”.

Tensioning the ribbed V-belt

This machine is equipped with an automatic spring-action V-belt tensioning device.

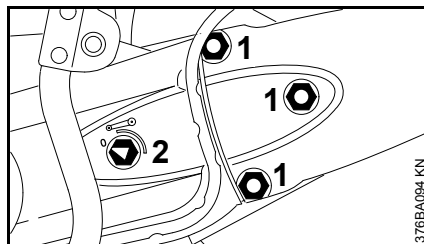

Prior to tensioning of the ribbed V-belt, the nuts (1) must be loosened and the arrow on the tensioning nut (2) must point to 0.

- otherwise loosen the nuts (1) and the tensioning nut (2) with the combination wrench counterclockwise – approx. 1/4 turn, as far as possible = 0

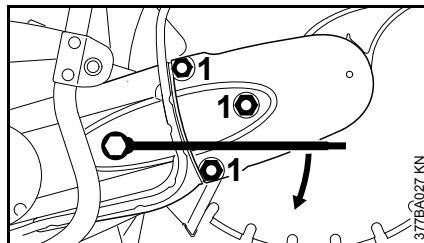

- to tighten the ribbed V-belt, fit the combination wrench over the tensioning nut as illustrated

! WARNING

The tensioning nut is spring-loaded – hold the combination wrench securely.

- Turn the tensioning nut clockwise approx. 1/8 turn – the tensioning nut will be engaged by the spring
- Continue turning approx. 1/8 turn – up to the stop

⚙ NOTICE

Do not turn the combination wrench further by force.

The V-belt is automatically tensioned by the force of the spring in this position.

- Remove the combination wrench from the tensioning nut
- Tighten nuts (1) on the V-belt guard

Retensioning the V-belt

The V-belt is retensioned without the aid of the tensioning nut.

- Unscrew the three nuts on the V-belt guard

The V-belt is automatically tensioned by the force of the spring.

- Retighten the nuts

Mounting an Abrasive Wheel

The engine must be switched off for fitting or replacement – set Master Control lever to **STOP** or **0**.

Blocking the shaft

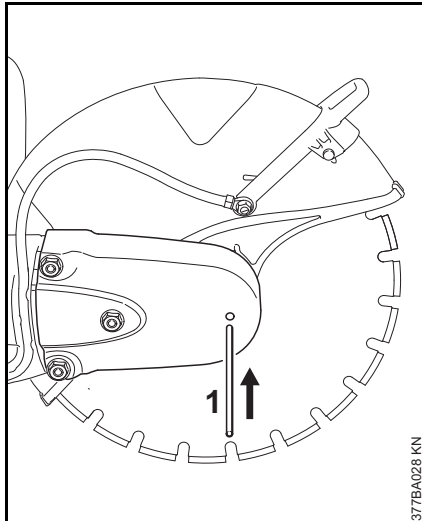

- Slide the locking pin (1) through the bore in the V-belt guard
- Turn the shaft with the combination wrench until the locking pin (1) engages in a bore behind the guard

Removing an abrasive wheel

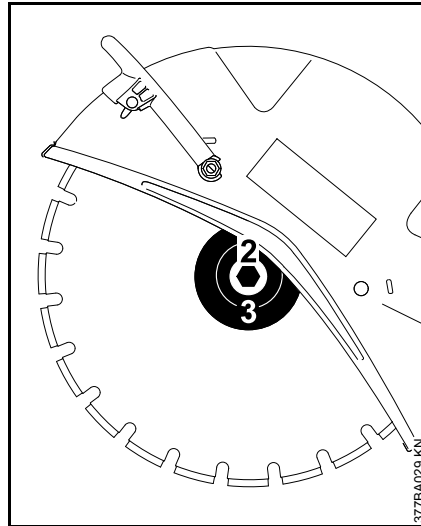

- Use the combination wrench to loosen and remove the hexagon head screw (2)
- Remove the front thrust washer (3) from the shaft together with the abrasive wheel

Fitting an abrasive wheel

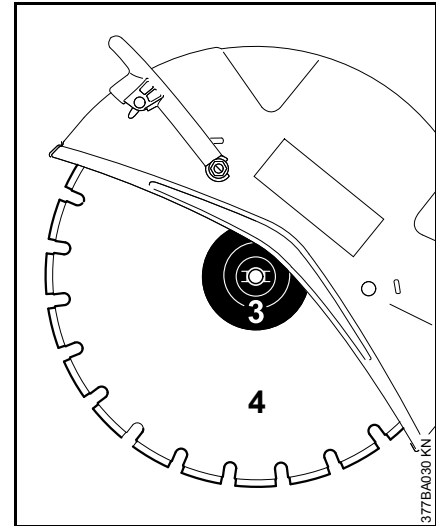

- Fit the new abrasive wheel (4)

! WARNING

Note the arrows indicating the direction of rotation on diamond abrasive wheels.

- Fit the front thrust washer (3). The catches of the front thrust washer (3) must engage in the shaft grooves.
- Screw in the hexagon bolt and **tighten it** with the combination wrench – if using a torque wrench, refer to the "Specifications" for the tightening torque
- Draw the locking pin out of the V-belt guard

 **WARNING**

Never use two abrasive wheels at the same time. The uneven wear creates a **risk of breaking and an injury hazard!**

Fuel

Your engine requires a mixture of gasoline and engine oil.

 **WARNING**

For health reasons, avoid direct skin contact with gasoline and avoid inhaling gasoline vapor.

STIHL MotoMix

STIHL recommends the use of STIHL MotoMix. This ready-to-use fuel mix contains no benzol or lead, has a high octane rating and ensures that you always use the right mix ratio.

STIHL MotoMix uses STIHL HP Ultra two-stroke engine oil for an extra long engine life.

MotoMix is not available in all markets.

Mixing Fuel

 **NOTICE**

Unsuitable fuels or lubricants or mix ratios other than those specified may result in serious damage to the engine. Poor quality gasoline or engine oil may damage the engine, sealing rings, hoses and the fuel tank.

Gasoline

Use only high-quality **brand-name** gasoline with a minimum octane rating of 90 – leaded or unleaded.

Gasoline with an ethanol content of more than 10% can cause running problems in engines with a manually adjustable carburetor and should not be used in such engines.

Engines equipped with M-Tronic deliver full power when run on gasoline with an ethanol content of up to 25% (E25).

Engine Oil

If you mix the fuel yourself, use only STIHL two-stroke engine oil or another high-performance engine oil in accordance with JASO FB, JASO FC, JASO FD, ISO-L-EGB, ISO-L-EGC or ISO-L-EGD.

STIHL specifies STIHL HP Ultra two-stroke engine oil or an equivalent high-performance engine oil in order to maintain emission limits over the machine's service life.

Mix Ratio

STIHL 50:1 two-stroke engine oil: 50 parts gasoline to 1 part oil

Examples

Gasoline Liters	STIHL engine oil 50:1	
	Liters	(ml)
1	0.02	(20)
5	0.10	(100)
10	0.20	(200)
15	0.30	(300)
20	0.40	(400)
25	0.50	(500)

- Use a canister approved for storing fuel. Pour oil into canister first, then add gasoline and mix thoroughly.

Storing Fuel

Store fuel only in approved safety-type fuel canisters in a dry, cool and safe location protected from light and the sun.

Fuel mix ages – only mix sufficient fuel for a few weeks work. Do not store fuel mix for longer than 30 days. Exposure to light, the sun, low or high temperatures can quickly make the fuel mix unusable.

STIHL MotoMix may be stored for up to 2 years without any problems.

- Thoroughly shake the mixture in the canister before fueling your machine.

WARNING

Pressure may build up in the canister – open it carefully.

- Clean the fuel tank and canister from time to time.

Dispose of remaining fuel and cleaning fluid properly in accordance with local regulations and environmental requirements.

Fueling



Preparing the machine

- Before fueling, clean the filler cap and the area around it so that dirt cannot fall into the tank
- Always position the machine so that the filler cap is facing upwards

WARNING

Never use a tool to open the bayonet filler cap. The cap can be damaged and fuel may escape.

Opening the filler cap

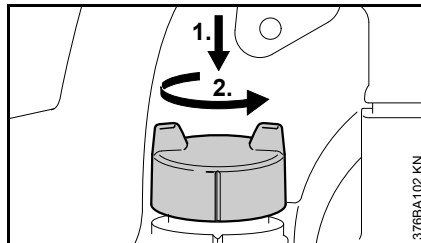

- Press the filler cap down as far as possible by hand, then turn it counterclockwise (approx. 1/8 turn) and remove

Refueling

Take care not to spill fuel while fueling and do not overfill the tank. STIHL recommends use of the STIHL filling system for fuel (special accessory).

Closing the filler cap

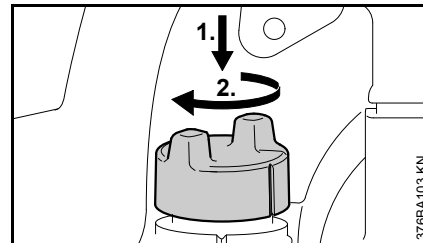

- Fit the cap and turn it until it engages in the bayonet catch
- Press the cap down as far as possible with your hand and turn it clockwise (approx. 1/8 of a turn) until it engages properly

Checking the lock

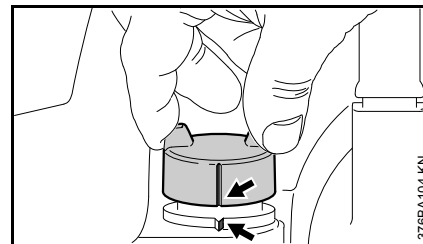

- Grip the cap – the cap is closed properly if it cannot be removed and the markings (arrows) on the cap and fuel tank are aligned

If the cap can be removed or the markings do not align, close the cap again – see sections "Closing the cap" and "Checking the lock".

Changing the fuel pickup body every year

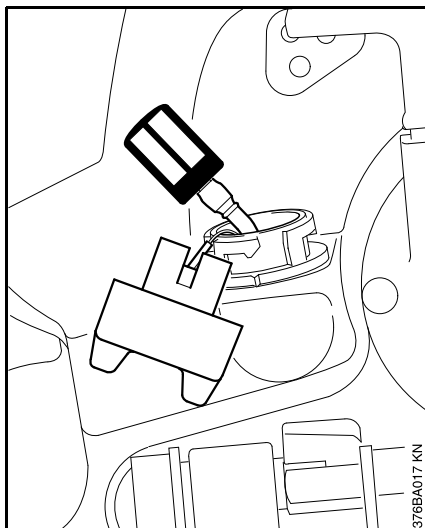

- Drain the fuel tank
- Pull the fuel pickup body out of the tank with a hook and disconnect it from the hose
- Connect a new fuel pickup body to the hose
- Return the fuel pickup body to the tank

Starting / Stopping the Engine

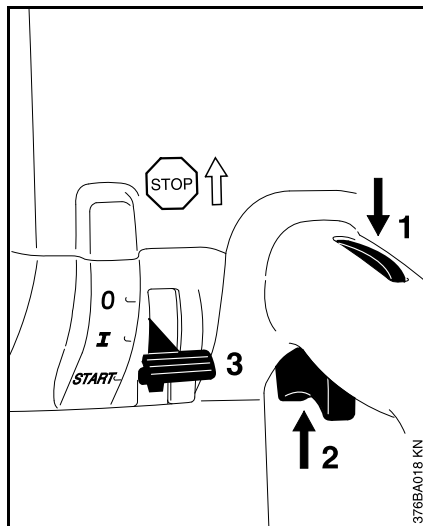

- Note the safety instructions. Refer to the chapter headed "Safety precautions and working techniques".
- Press throttle trigger lockout (1) and throttle trigger (2) simultaneously
- Hold both triggers down
- Move the master control lever (3) to **START** and hold it in position too
- Release the throttle trigger, master control lever and throttle trigger lockout in succession = **starting throttle position**

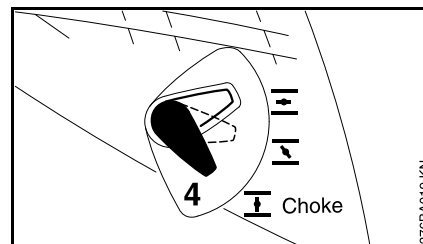

- Set the choke (4) according to the engine temperature
- ⏏ If engine is **cold**
 - ⏏ if the engine is **warm** (even if the engine is already running but is still cold or if the warm engine was shut off for less than 5 min)
 - ⏏ if the engine is **hot** (if the hot engine was switched off for longer than 5 min)

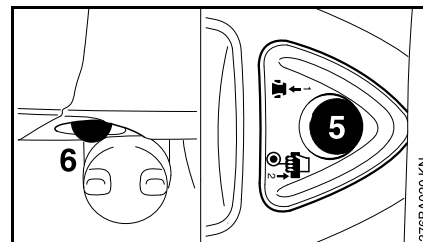

- Press the button (5) of the decompression valve before each starting procedure
- Press the bulb (6) of the manual fuel pump 7-10 times – even when the bulb is still filled with fuel

Starting

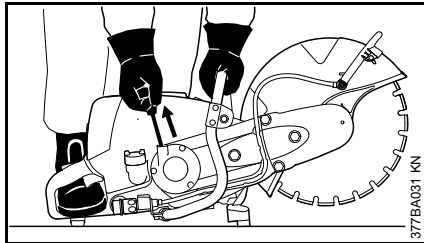

- Place the cut-off machine carefully on the ground, ensuring that the abrasive wheel cannot touch the ground or any objects. There must not be anyone within the swivel range of the cut-off machine
- Make sure you have a firm footing
- Press the cut-off machine firmly against the ground, holding the handle with your left hand, thumb wrapped round the handle
- Place your right foot into the rear handle
- Pull the starter grip slowly with your right hand until you feel it engage – then give it a brisk strong pull – do not pull out the starter rope all the way



NOTICE

Do not let the starter grip snap back – it **may break!** Guide it back into the housing in the opposite direction so that it can rewind properly.

When the engine has turned over for the first time

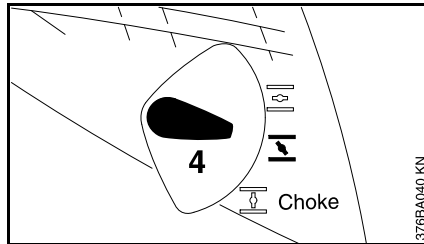

- Set choke lever (4) to – press the button of the decompression valve again before each starting attempt and continue cranking

Once the engine is running

- Squeeze throttle trigger fully and let engine run at full throttle for approx. 30 s
- When it has warmed up, set the choke lever to

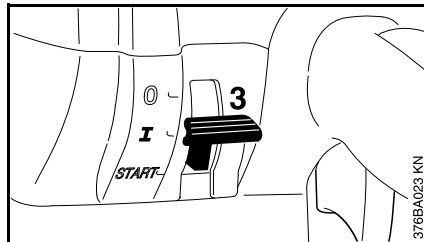

- The master control lever (3) moves to the normal position **I** when the throttle trigger is squeezed

If the carburetor has been set correctly, the abrasive wheel should not rotate when the engine is idling.

The cut-off machine is now ready for use.

Switching off the engine

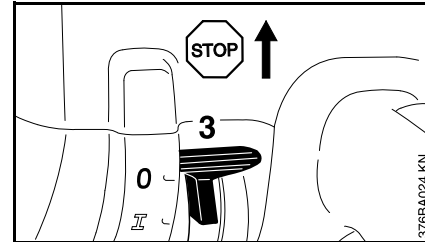

- Slide the master control lever (3) to **STOP** or **0**

Additional hints on starting

If the engine does not start

The choke lever was not returned to in time after the engine turned over for the first time.

- Move the master control lever to **START = starting throttle position**
- Set the choke lever to = warm start, even if the engine is cold
- Pull the starter rope through 10-20 times to ventilate the combustion chamber
- Restart the engine

If the tank has been drained completely

- Refueling
- Press the manual fuel pump bulb 7-10 times – even if it is full of fuel

- Set the choke lever in accordance with the engine temperature
- Restart the engine

Air Filter System

Basic information

The average filter life is more than 1 year. Do not dismantle the filter cover or fit a new air filter unless there is a noticeable loss of engine power.

In the long-life air filter system with the cyclone pre-separation system, dirty air is drawn in and deliberately rotated. The larger and heavier particles carried in the air are thus expelled and extracted. Only pre-cleaned air enters the air filter system and the result is extremely long filter life.

Replacing the air filter

Only if there is a noticeable loss of engine power

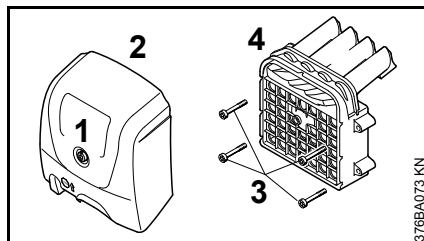

- Remove the locking screw (1) on the filter cover
- Remove the filter cover (2)
- Remove all coarse dirt from the area around the filter and the inside of the filter cover

- Remove screws (3)
- Remove filter housing (4)

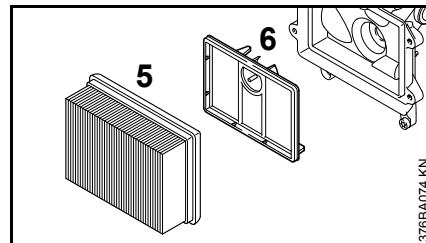

- Pull main filter (5) out of the filter housing
- Set choke lever to \perp
- Remove the auxiliary filter (6) from filter base – ensuring that dirt does not enter the intake area
- Clean the filter area
- Remount main filter and new auxiliary filter with the remaining filter components
- Refit filter cover
- Tighten down the locking screw

Only high-quality air filters should be used, to protect the engine against ingress of abrasive dust.

STIHL recommends the use of genuine STIHL air filters. The high quality of these parts will ensure troublefree operation, a long service life for the engine and extremely long filter life.

Adjusting the Carburetor

Basic information

The ignition system of this cut-off machine is equipped with an electronic maximum speed limiter. The maximum speed cannot be increased beyond a specified limit.

The carburetor is equipped with a factory-installed standard setting.

The carburetor has been adjusted for optimum performance and fuel efficiency in all operating states.

Preparing the machine

- Switching off the engine
- Check the air filter – clean or replace it if necessary
- Check the spark arresting screen in the muffler (present only in some countries) – clean or replace it if necessary

Standard setting

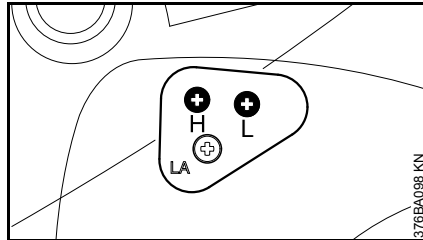

- Turn the high speed adjusting screw (H) counterclockwise as far as possible (max. 3/4 turn)
- Turn the low speed adjusting screw (L) clockwise as far as possible – then turn it 3/4 turn counterclockwise

Setting the idle speed

- Make standard setting
- Start engine and let it warm up

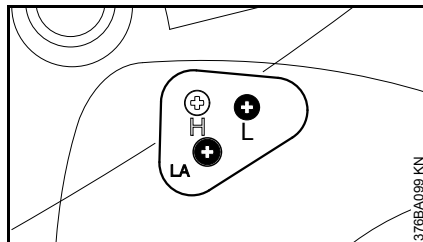

Engine stops when idling

- Turn the idle speed adjusting screw (LA) clockwise until the abrasive wheel begins to rotate – then turn it back 1 turn

Abrasive wheel runs when idling

- Turn the idle speed screw (LA) counterclockwise until the abrasive wheel stops running – then turn another full turn in the same direction

! WARNING

If the abrasive wheel continues to keep rotating in idle even after adjustment, have the cut-off machine checked by a servicing dealer.

Speed erratic when idling; poor acceleration (despite adjustment to LA setting)

The idle setting is too lean.

- Turn the low speed adjusting screw (L) approx. 1/4 turn counterclockwise until the engine runs and accelerates smoothly – max. up to the stop

Idle speed cannot be increased sufficiently via the idle speed adjusting screw (LA), engine stops when changing from part-load to idle speed

The idle setting is too rich.

- Turn low speed adjusting screw (L) approx. 1/4 turn clockwise.

Whenever the low speed adjusting screw (L) has been adjusted, it is usually also necessary to readjust the idle speed adjusting screw (LA).

Correcting the carburetor setting for use at high altitudes

The setting may have to be marginally corrected if engine performance is unsatisfactory at high altitudes:

- Make standard setting
- Let the engine warm up
- Turn the high speed adjusting screw (H) slightly clockwise (leaner) – max. up to the stop

NOTICE

After descending from a high altitude, restore the carburetor setting to the standard setting.

If you make the setting too lean it will increase the risk of engine damage through lack of lubrication and overheating.

Spark Arresting Screen in Muffler

In some countries, the mufflers are fitted with a spark arresting screen.

- If engine performance deteriorates, check the spark arresting screen in the muffler.

WARNING

Wait until engine has cooled completely before performing the following operations.

Versions

There are two different spark arresting screen versions in the muffler.

- Spark arresting screen fastened with clip
- Spark arresting screen fastened with screw

Spark arresting screen fastened with clip

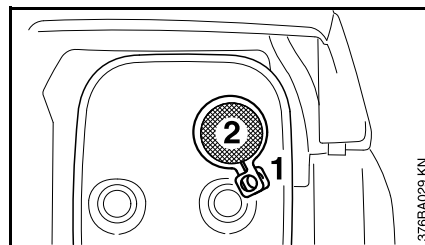

- Use a suitable tool to squeeze ends of clip (1) together and then lift the clip away
- Remove the spark arresting screen (2) from the muffler

- Clean the soiled spark arresting screen
- If the screen is damaged or heavily carbonized, fit a new one
- Refit the spark arresting screen in reverse order of steps

Spark arresting screen fastened with screw

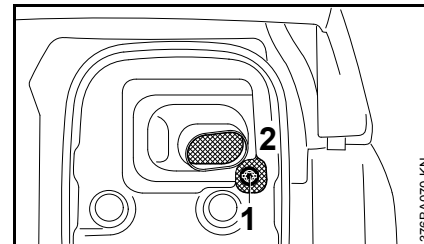

- Undo screw (1)
- Pull out spark arresting screen (2) with a suitable tool
- Clean the soiled spark arresting screen
- If the screen is damaged or heavily carbonized, fit a new one
- Refit the spark arresting screen in reverse order of steps

Spark Plug

- If the engine is down on power, difficult to start or runs poorly at idle speed, first check the spark plug.
- Fit a new spark plug after about 100 operating hours – or sooner if the electrodes are badly eroded. Install only suppressed spark plugs of the type approved by STIHL – see "Specifications".

Removing the spark plug

- Switch off the engine – move stop switch to **STOP** or **0**

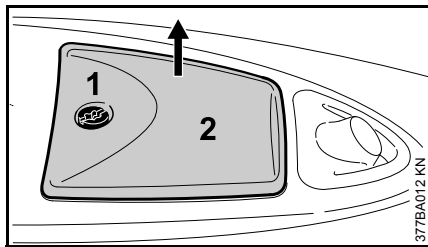

- Unscrew the screw (1) and remove cap (2) – screw (1) is secured in the cap (2) to prevent loss

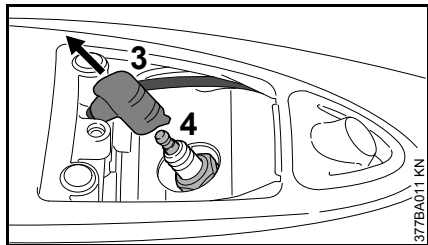

- Remove the spark plug boot (3).
- Unscrew the spark plug (4).

Checking the Spark Plug

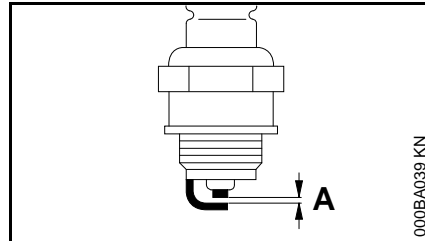

- Clean dirty spark plug.
- Check electrode gap (A) and readjust if necessary – see "Specifications".
- Rectify the problems which have caused fouling of the spark plug.

Possible causes are:

- Too much oil in fuel mix.
- Dirty air filter.
- Unfavorable running conditions.

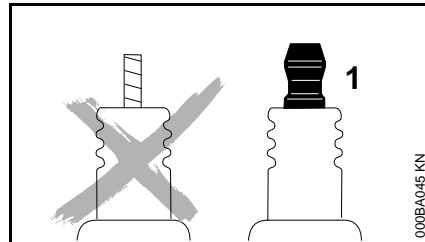

! WARNING

Arcing may occur if the adapter nut (1) is loose or missing. Working in an easily combustible or explosive atmosphere may cause a fire or an explosion. This can result in serious injuries or damage to property.

- Use resistor type spark plugs with a properly tightened adapter nut.

Installing the spark plug

- Fit the spark plug by hand and screw it in
- Tighten spark plug with combination wrench
- Press the spark plug boot firmly onto the spark plug
- Position the cap for the spark plug boot and screw it down

Replacing the V-belt

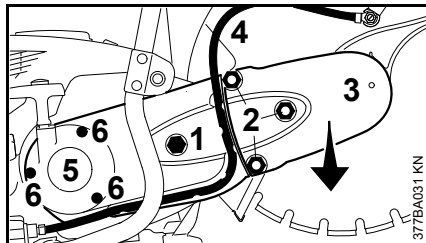

- The arrow on the tensioning nut (1) must point to 0 – to this end, turn the tensioning nut (1) with the combination wrench counterclockwise – approx. 1/4 turn, as far as possible = 0
- Unscrew the nuts (2) from the studs
- Remove the V-belt guard (3) and remove the V-belt from the front pulley
- Remove the "support with guard".
- Remove the hose (4) from the guide of the starter cover (5)
- Remove the screws (6) from the starter cover
- Remove the starter cover
- Remove the defective V-belt from the cast arm

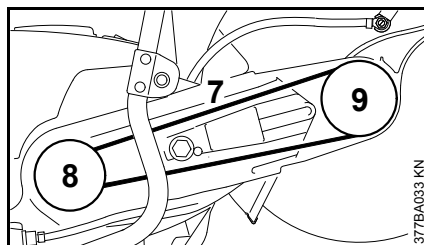

- Carefully fit a new poly V-belt (7) in the cast arm and insert it in the front poly V-belt pulley (8) on the engine
- Fit the starter cover
- Position the "support with guard" against the cast arm
- Fit the poly V-belt in the front poly V-belt pulley (9)
- Position belt guard
- Align the studs in the support with the nuts in the V-belt guard
- Screw the nuts onto the studs – do not tighten them yet
- Place hose in the guide of the starter cover

Continue as described in the chapter "Tensioning the V-belt".

Cut-off Machine Cart

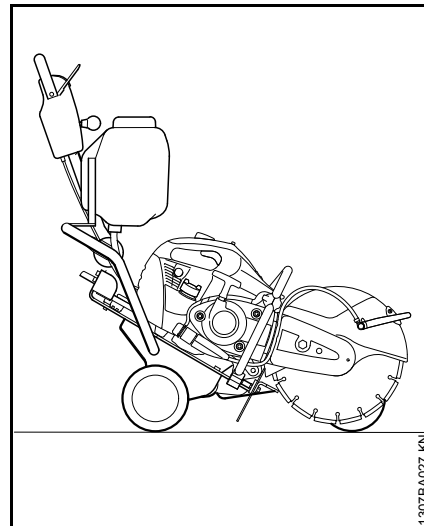

The cut-off machine can be mounted on the STIHL cut-off machine cart FW 20 (special accessory) in a few easy steps.

The cut-off machine cart makes it easier to

- repair damaged roadways
- apply roadway markings
- cut expansion joints

Storing the Machine

If the machine is to remain out of use for approx. 3 months or more

- Drain and clean the fuel tank in a well ventilated place
- Dispose of fuel in accordance with the regulations and having regard for the environment
- Run the engine until the carburetor is dry, this helps to prevent the carburetor diaphragms sticking together
- Remove the abrasive wheel
- Thoroughly clean the machine, especially the cylinder fins
- Store machine in a safe and dry place. Protect against unauthorized use (e. g., by children)

Maintenance and Care

The following maintenance intervals apply in normal operating conditions. The specified intervals must be shortened accordingly when working for longer than normal or under difficult cutting conditions (extensive dust, etc.).		Before starting work	At the end of work and/or daily	Whenever tank is refilled	Weekly	Monthly	Yearly	If faulty	If damaged	As required
Complete machine	Visual inspection (condition, leaks)	X		X						
	Clean		X							
Operating elements	Function tests	X		X						
Manual fuel pump (if present)	Check	X								
	Have repaired by a specialist dealer ¹⁾								X	
Fuel pickup body in fuel tank	Check							X		
	Replace						X		X	X
Fuel tank	Clean					X				
Poly V-belt	Clean / retension					X				X
	Replace								X	X
Air filter (all filter components)	Change	Only if there is a noticeable loss of engine power								
Cooling air intake slits	Clean		X							
Cylinder fins	Have them cleaned by a servicing dealer ¹⁾						X			
Spark arresting screen ²⁾ in muffler	Check		X							
	Clean or replace									X
Water attachment	Check	X						X		
	Have them maintained by a servicing dealer ¹⁾								X	
Carburetor	Check idle adjustment – abrasive wheel must not rotate	X		X						
	Readjust idle speed									X
Spark plug	Adjust electrode gap							X		
	Replace after 100 hours operation									
All accessible screws, nuts and bolts (not adjusting screws)	Retighten		X							X

The following maintenance intervals apply in normal operating conditions. The specified intervals must be shortened accordingly when working for longer than normal or under difficult cutting conditions (extensive dust, etc.).		Before starting work	At the end of work and/or daily	Whenever tank is refilled	Weekly	Monthly	Yearly	If faulty	If damaged	As required
Anti-vibration elements	Check	X						X		X
	Have them replaced by a servicing dealer ¹⁾								X	
Abrasive wheel	Check	X		X						
	Replace								X	X
Supports / bars / rubber buffers (underneath the machine)	Check		X							
	Replace								X	X
Safety information label	Replace								X	

1) STIHL recommends STIHL servicing dealers

2) present only in some countries

Main Parts

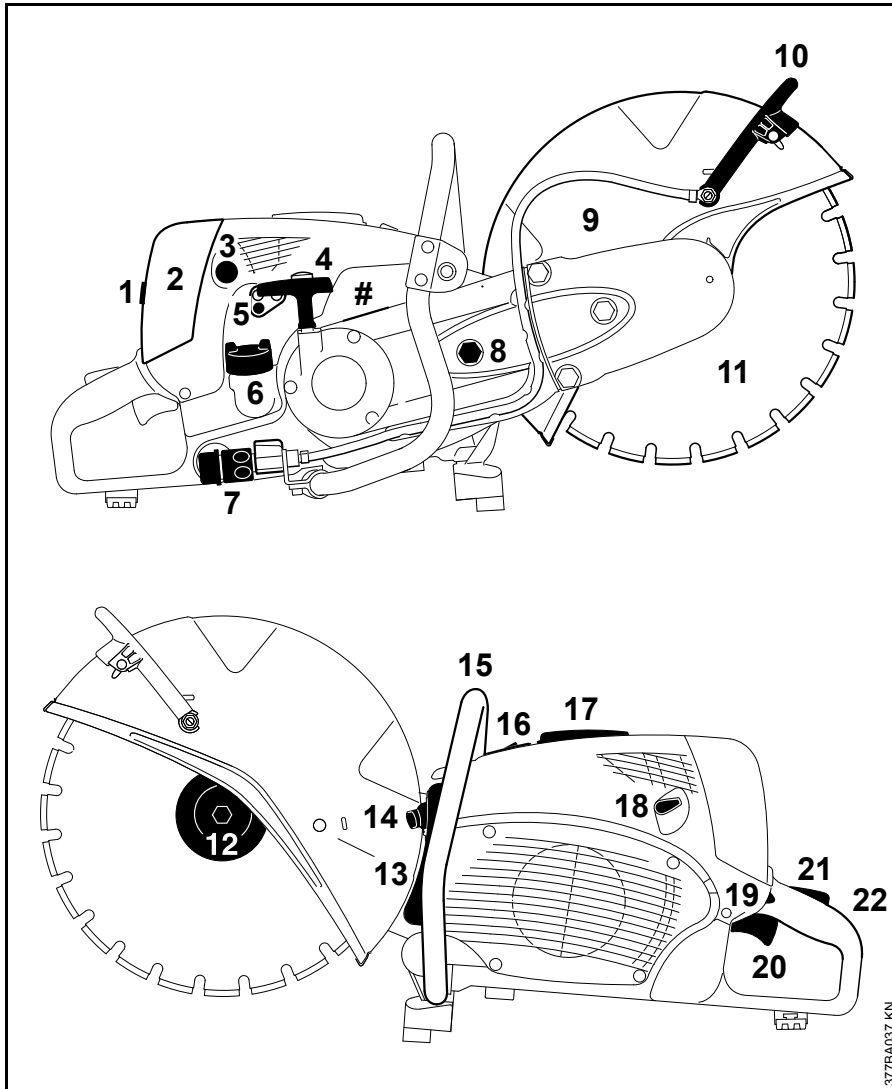

- 1 Screw plug
- 2 Filter cover
- 3 Manual fuel pump
- 4 Starter grip
- 5 Carburetor adjusting screws
- 6 Filler cap
- 7 Water attachment
- 8 Tensioning nut
- 9 Guard
- 10 Adjusting lever
- 11 Abrasive wheel
- 12 Front thrust washer
- 13 Muffler
- 14 Spark arresting screen (present only in some countries)
- 15 Handlebar
- 16 Decompression valve
- 17 Cap for spark plug boot
- 18 Choke lever
- 19 Master control lever
- 20 Throttle trigger
- 21 Throttle lever lock
- 22 Rear handle
- # Machine number

377BA037 KN

Specifications

Engine

STIHL single cylinder two-stroke engine

Displacement:	98.5 cm ³
Cylinder bore:	56 mm
Piston stroke:	40 mm
Engine power according to ISO 7293:	5.0 kW (6.8 HP) at 9300 rpm
Idling speed:	2200 rpm
Max. spindle speed to ISO 19432:	4290 rpm

Ignition system

Electronic magneto ignition

Spark plug (suppressed):	Bosch WSR 6 F, NGK BPMR 7 A
Electrode gap:	0.5 mm

Fuel system

All-position diaphragm carburetor with integral fuel pump

Fuel tank capacity:	1200 cm ³ (1.2 l)
---------------------	------------------------------

Air filter

Main filter (paper filter) and flocked wire mesh auxiliary filter

Weight

without fuel, without abrasive wheel, with water attachment 13.0 kg

Abrasive wheels

The quoted maximum permissible operating speed of the abrasive wheel must be greater than or equal to the maximum spindle speed of the cut-off machine used.

Max. thickness:	4.8 mm
Bore diameter/spindle diameter:	20 mm
Tightening torque:	30 Nm

Composite resin abrasive wheels

Outside diameter:	400 mm
Minimum outside diameter of thrust washers:	140 mm
Max. depth of cut:	130 mm

Diamond abrasive wheels

Outside diameter:	400 mm
Minimum outside diameter of thrust washers:	103 mm
Max. depth of cut:	145 mm

The STIHL diamond abrasive wheel with an outside diameter of 418 mm is also approved. When this diamond abrasive wheel is used, the minimum outside diameter of the thrust washers must be 118 mm. The maximum depth of cut increases to 150 mm.

Exhaust Emissions

The CO₂ value measured in the EU type approval procedure is specified at www.stihl.com/co2.

The measured CO₂ value was determined on a representative engine in accordance with a standardized test procedure under laboratory conditions and does not represent either an explicit or implied guarantee of the performance of a specific engine.

The applicable exhaust emission requirements are fulfilled by the intended usage and maintenance described in this instruction manual. The type approval expires if the engine is modified in any way.

Maintenance and Repairs

Users of this machine may only carry out the maintenance and service work described in this user manual. All other repairs must be carried out by a servicing dealer.

STIHL recommends that you have servicing and repair work carried out exclusively by an authorized STIHL servicing dealer. STIHL dealers are regularly given the opportunity to attend training courses and are supplied with the necessary technical information.

When repairing the machine, only use replacement parts which have been approved by STIHL for this power tool or are technically identical. Only use high-quality replacement parts in order to avoid the risk of accidents and damage to the machine.

STIHL recommends the use of original STIHL replacement parts.

Original STIHL parts can be identified by the STIHL part number, the **STIHL** logo and the STIHL parts symbol  (the symbol may appear alone on small parts).

Disposal

Observe all country-specific waste disposal rules and regulations.

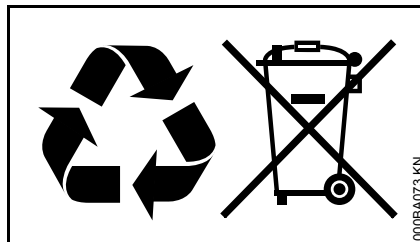

STIHL products must not be thrown in the garbage can. Take the product, accessories and packaging to an approved disposal site for environment-friendly recycling.

Contact your STIHL servicing dealer for the latest information on waste disposal.

0458-589-8321-A

AUS



www.stihl.com



0458-589-8321-A